

iMIX®-3 Black

Height: 32.8" Width: 12.6" Depth: 24.0"
(83.3cm) (32.0cm) (61.0cm)



- 4.4gal (16.7L) hot water tank to meet peak serving times
- Alphanumeric display communicates advertising messages, machine status and technical support contact information
- Auger motors with RPM feedback monitoring assure consistent flavors and profits by controlling powder dosing
- Capacity: Three 8lb (3.6kg) hoppers
- Cup clearance at 7.25" (18.4cm) to accommodate popular cup sizes [adjustable to 8.12" (20.6cm)]
- Front of machine access to tank drain, dump valves, auger and whipper motors and control board for easy service set up and calibration
- High speed heavy-duty whipper for complete product mixing
- Low product detection system alerts audibly and with message on display when hoppers are low
- High efficiency LED lighted front graphics for merchandising
- Night mode to prevent pilferage
- Spring-loaded, all metal auger drive system for easy hopper installation

Agency:



Specifications

Product #: 36900.0000

Door: Side Hinge

Water Access: Plumbed

Dispense: Push Button

Finish: Black

Hoppers: Three

Additional Features

Electrical & Capacity

Volts*	Amps	Watts	Cord Attached	Plug Type	8oz cups/hr 236ml cups/hr	Input H ₂ O Temp.	Phase	# Wires plus Ground	Hertz
120	15	1800	Yes	NEMA 5-15P	72	60°F (15.5°C)	1	2	50/60

*When a BUNN is machine rated 120/208-240V, 120/208V or 120/240V, the higher voltage is the supply voltage needed to power the machine. The 120V is there to supply power to some components rated 120V in the machine, but it is not the supply voltage and would not power the machine if the machine is marked with the before mentioned ratings.

Plumbing Requirements

PSI	kPa	Fitting Supplied	Water Flow Required (GPM)
20-100	138-689	1/4" Male Flare Fitting	-

CAD Drawings

2D	Revit	KLC
●	●	●

WARNING: This product can expose you to chemicals including Bisphenol A (BPA), which is known to the State of California to cause birth defects or other reproductive harm. For more information go to www.P65Warnings.ca.gov



BUNN® reserves the right to change specifications and product design without notice. Such revisions do not entitle the buyer to corresponding changes, improvements, additions or replacements for previously purchased equipment. For most current specifications and other info visit bunn.com.

Last Updated:
05/09/2023

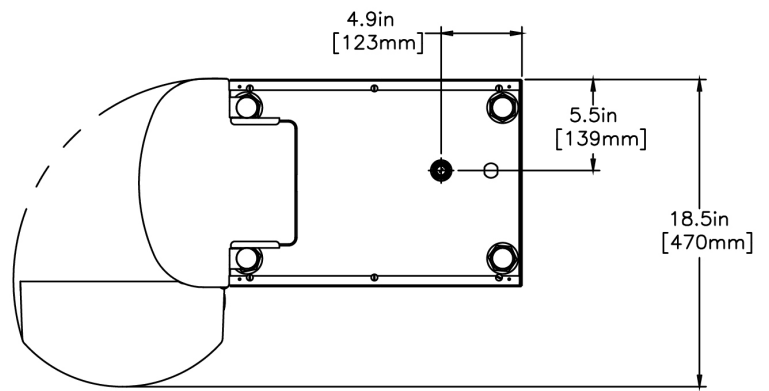
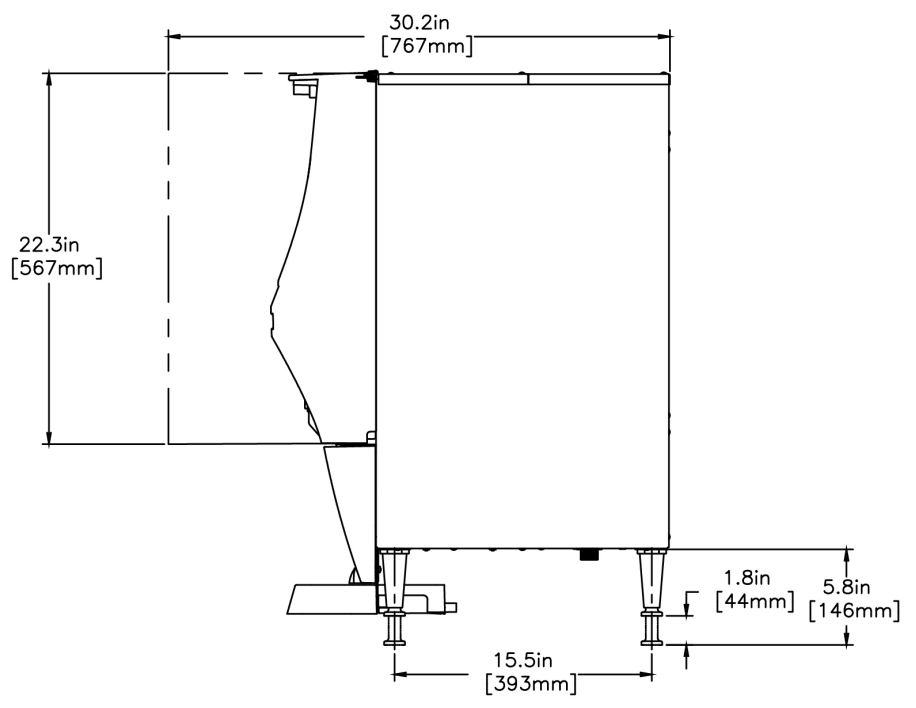
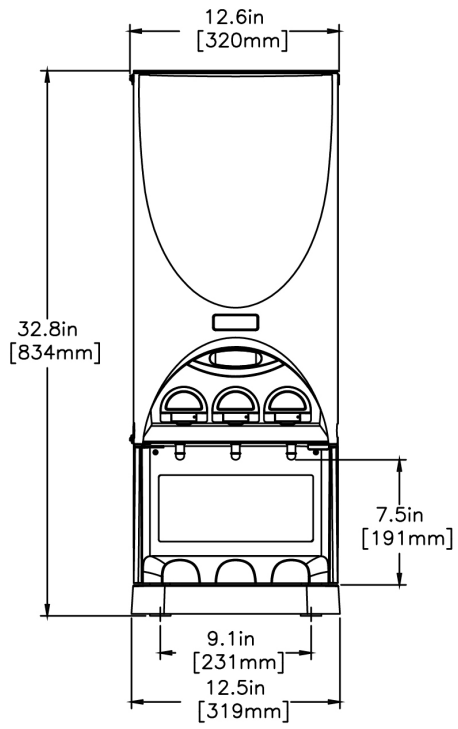

	Unit			Shipping				
	Height	Width	Depth	Height	Width	Depth	Weight	Volume
English	32.8 in.	12.6 in.	24.0 in.	41.7 in.	17.1 in.	29.5 in.	101.765 lbs	12.144 ft³
Metric	83.3 cm	32.0 cm	61.0 cm	105.9 cm	43.3 cm	74.9 cm	46.161 kgs	0.344 m³



BUNN® reserves the right to change specifications and product design without notice. Such revisions do not entitle the buyer to corresponding changes, improvements, additions or replacements for previously purchased equipment. For most current specifications and other info visit bunn.com.

Last Updated:
05/09/2023

Related Products & Accessories:iMIX®-3 Black(36900.0000)



DISPLAY GRAPHICS
IMIX-3

Product #: 37457.0000



DISPLAY, GRAPHICS
HOT CHOC

Product #: 37457.0002



WATER FILTER,
EQHP-10L

Product #: 39000.0001



WATER FILTER,
EQHP-10

Product #: 39000.0004



SYSTEM, WQ-55(2)5L

Product #: 56000.0001



SYSTEM, WQ-55(2)5

Product #: 56000.0004



SYSTEM, WEQ-10(1.5)5L

Product #: 56000.0024



SYSTEM, WEQ-10(1.5)5

Product #: 56000.0027



CARTRIDGE, WQ-55(2)5L

Product #: 56000.0101



CARTRIDGE, WQ-55(2)5

Product #: 56000.0104



CARTRIDGE, WEQ-10
(1.5)5L

Product #: 56000.0121



CARTRIDGE, WEQ-10
(1.5)5

Product #: 56000.0122



BUNN® reserves the right to change specifications and product design without notice. Such revisions do not entitle the buyer to corresponding changes, improvements, additions or replacements for previously purchased equipment. For most current specifications and other info visit bunn.com.

Last Updated:
05/09/2023

Serving & Holding Options: iMIX®-3 Black(36900.0000)

Serving and Holding selections are currently unavailable. Please contact your sales representative to find out more information.



BUNN® reserves the right to change specifications and product design without notice. Such revisions do not entitle the buyer to corresponding changes, improvements, additions or replacements for previously purchased equipment. For most current specifications and other info visit bunn.com.

Last Updated:
05/09/2023